

KIGO standard

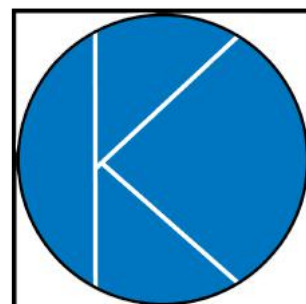

Suspension par rails / Aufhängesystem mit Schienen

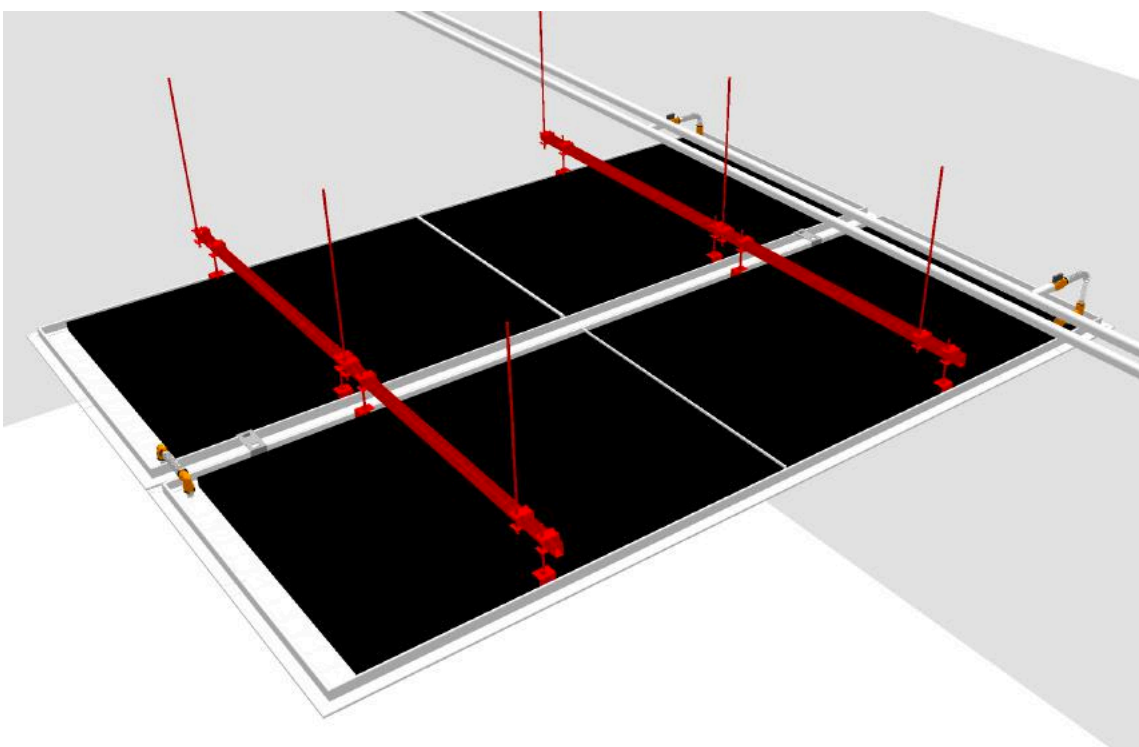

by SOLTOP Energie AG

KIGO®



Torx T25

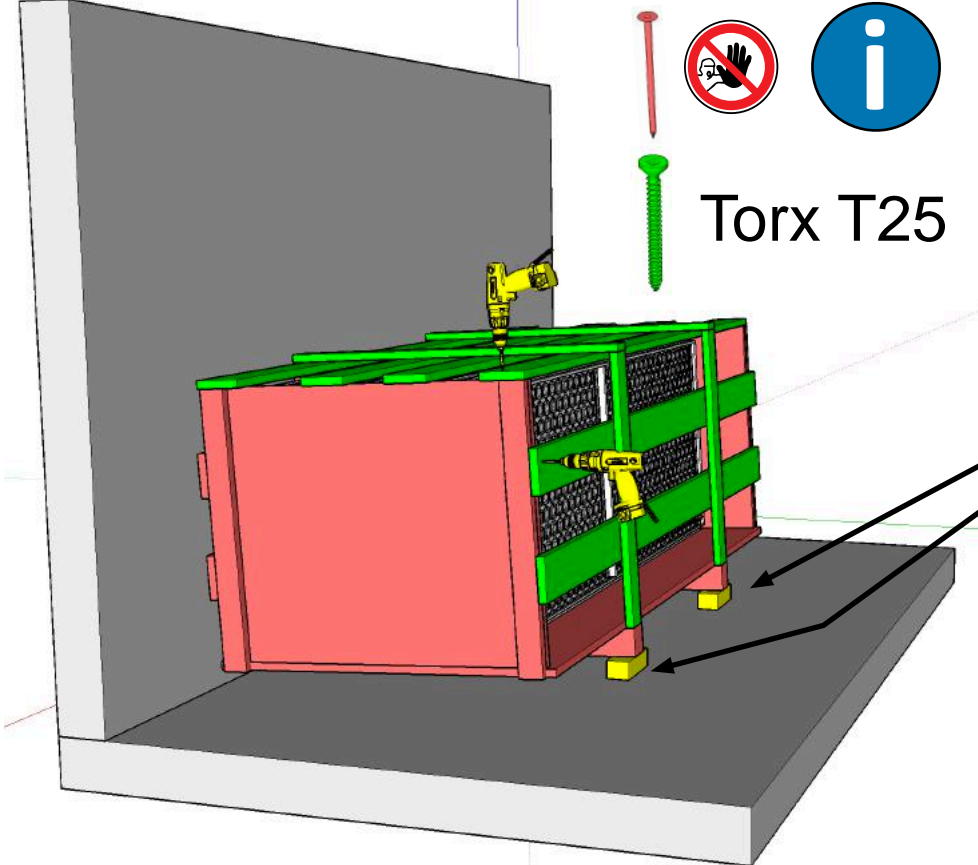
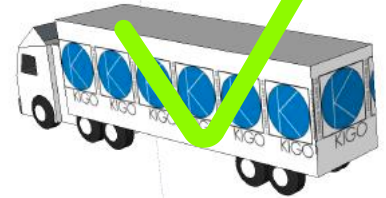
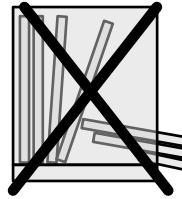
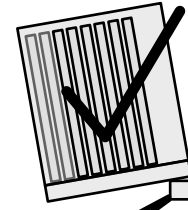

08.20.15RD.GRAISSE



08.20.15RD.01.03



16.FN4995.401906

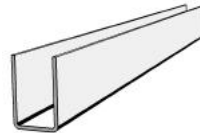

08.03.03.U33

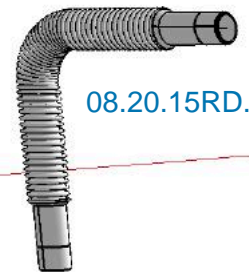

08.20.15RD.01.02



08.03.03.RD02

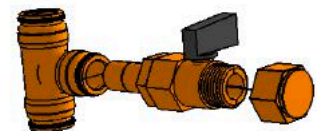

08.20.15RD.09



08.03.03.RD04.01.M8



08.20.15RD.05



08.03.00.RD06



08.20.15RD.01.01

08.05.RD15.LLL

OPTION

01.04.TS13.3

05.09.06.STAB.1/2" _120

08.20.15RD.06

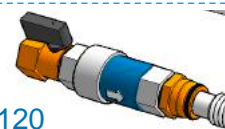

08.20.15RDL.W.X

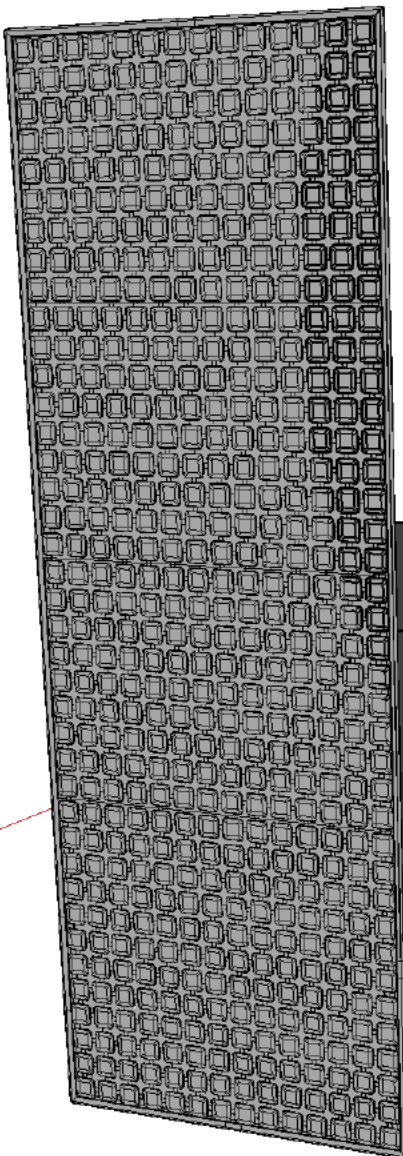

1

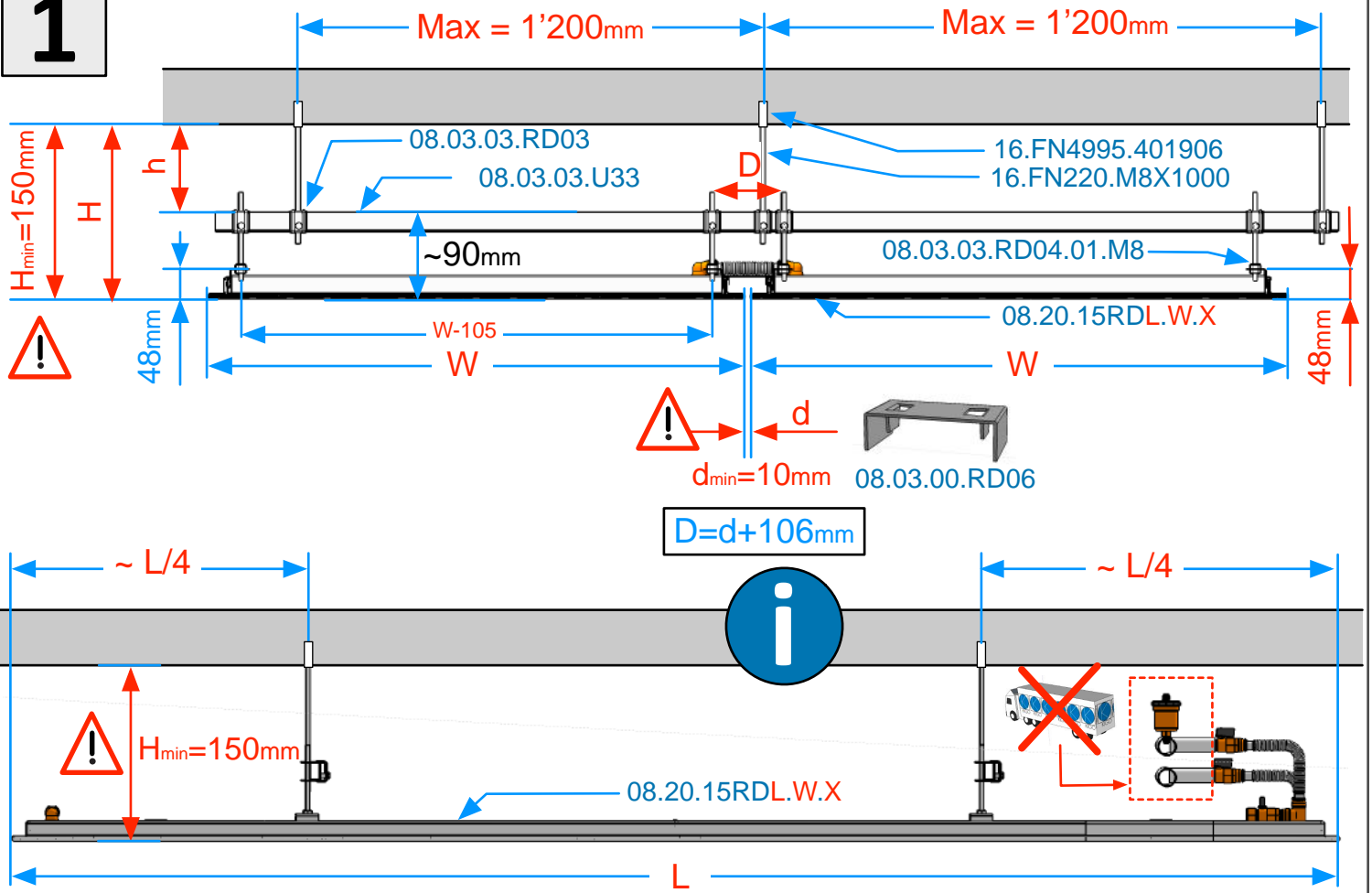

2

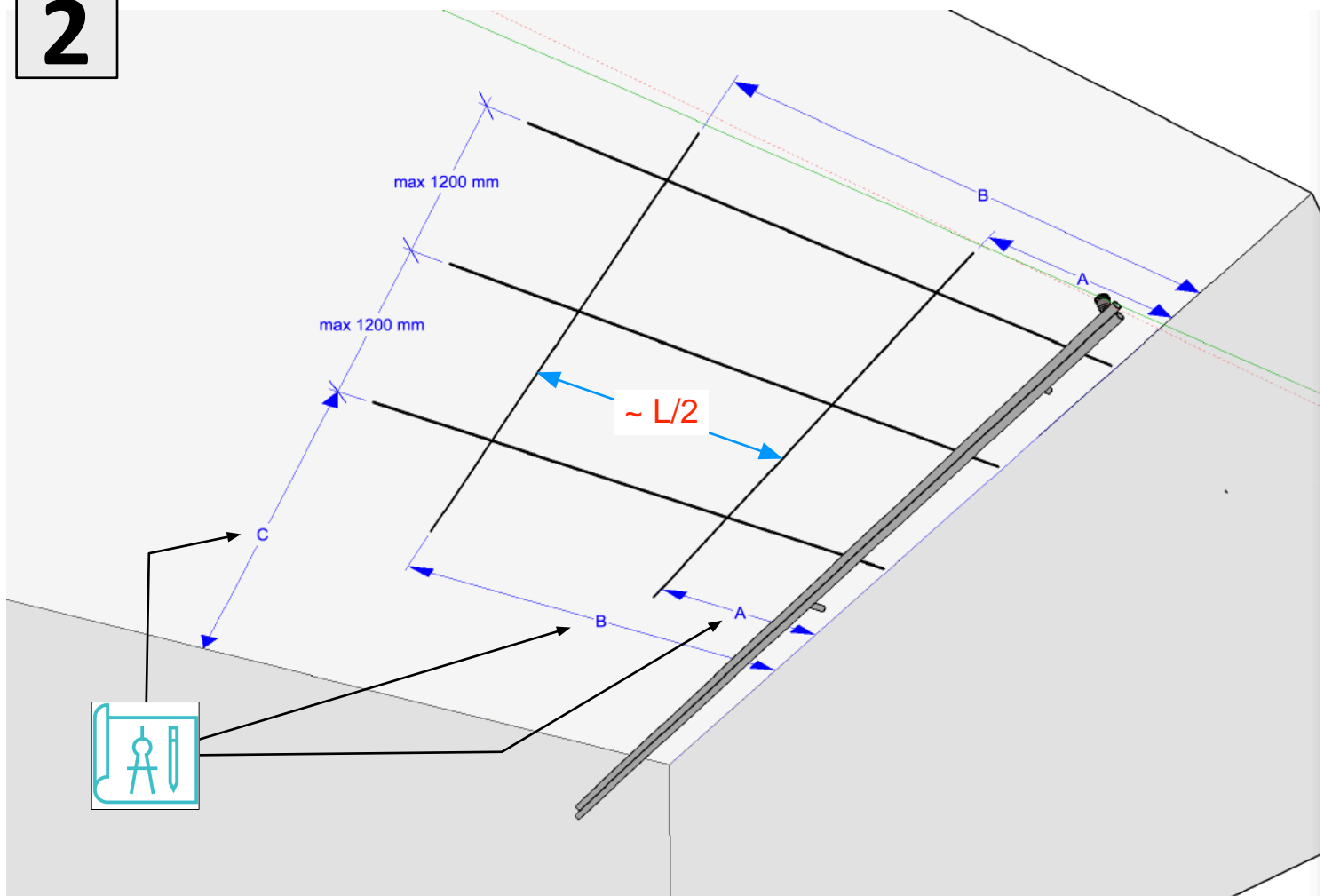

3

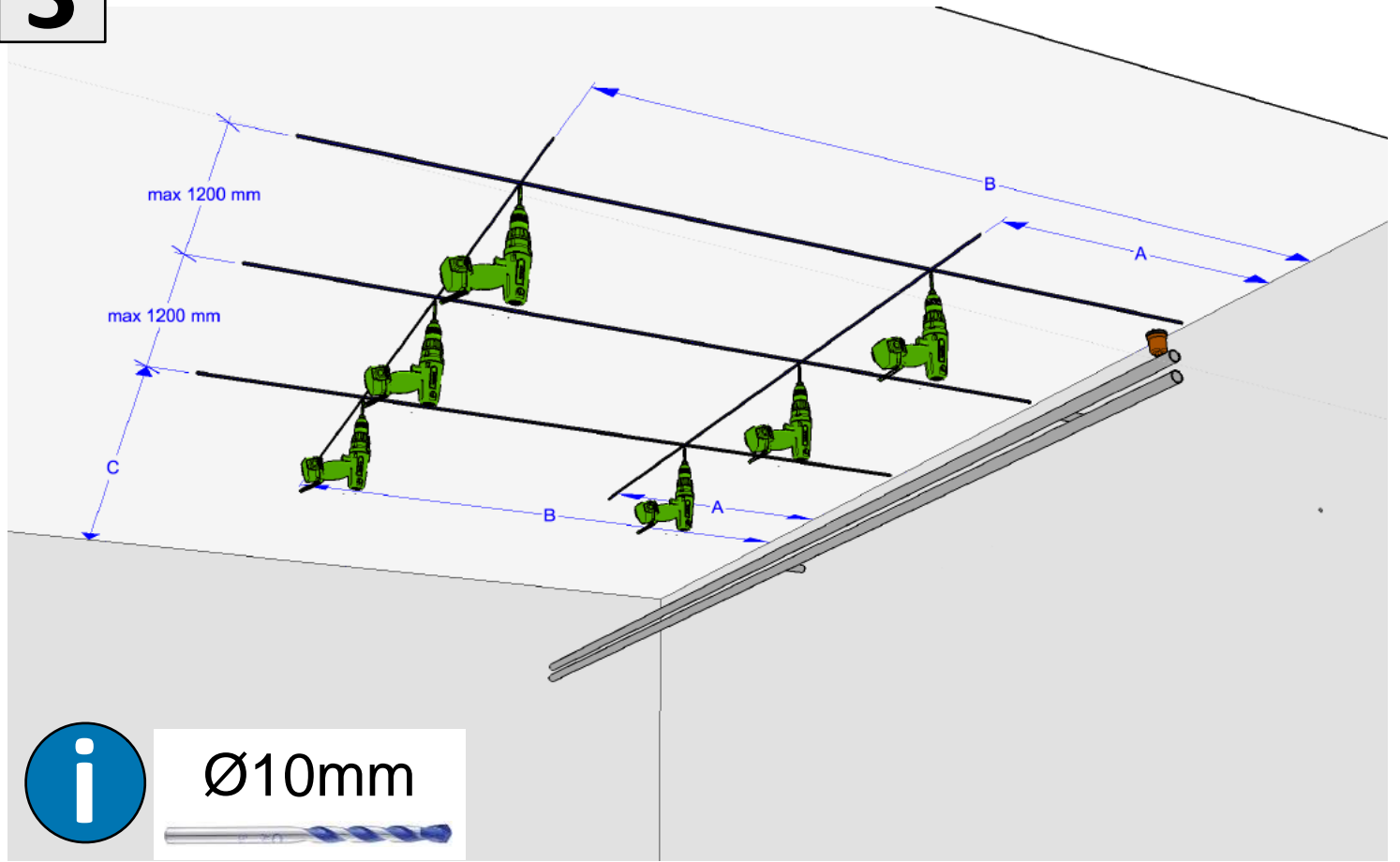

4

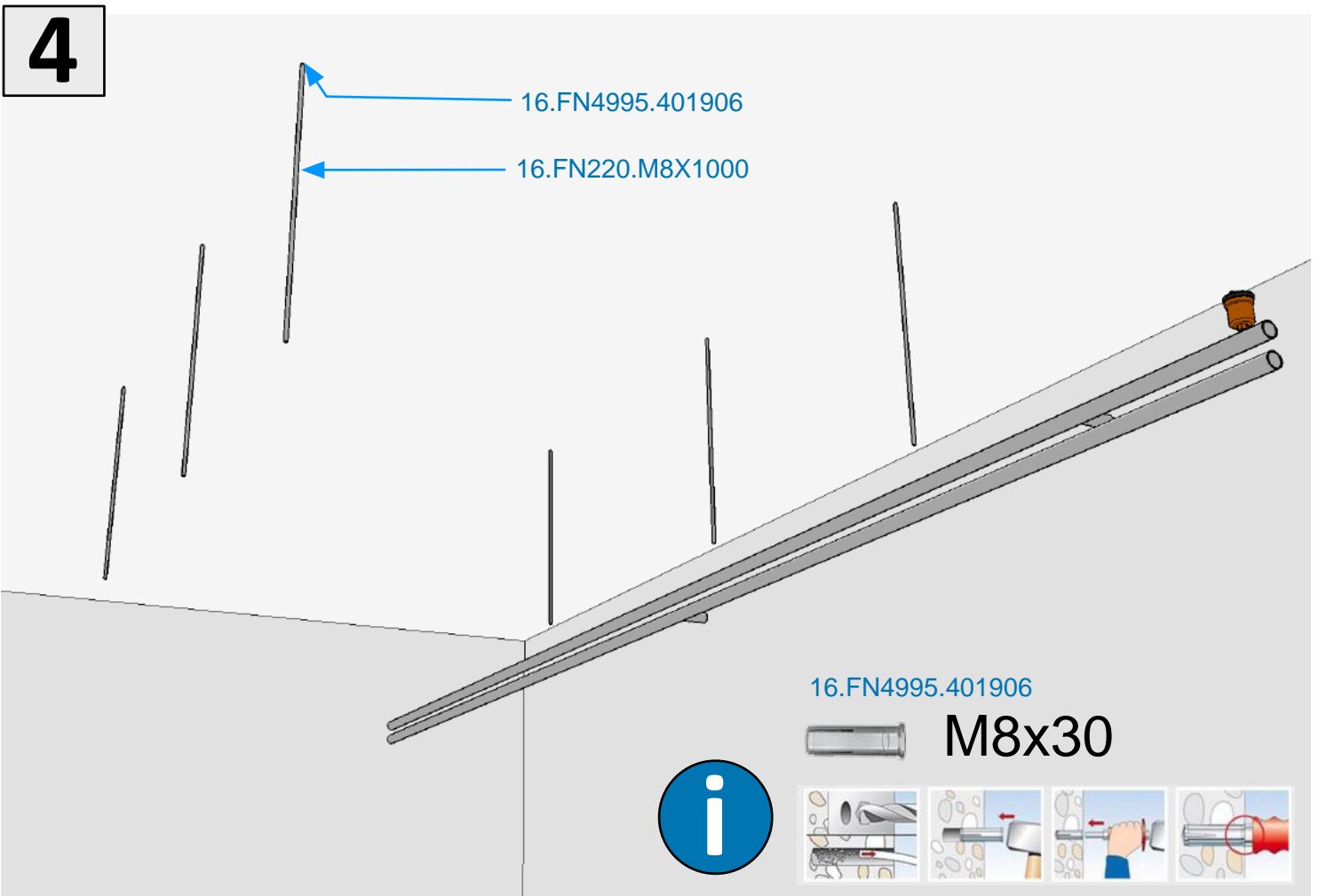

5

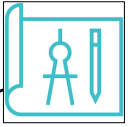

08.03.03.U33

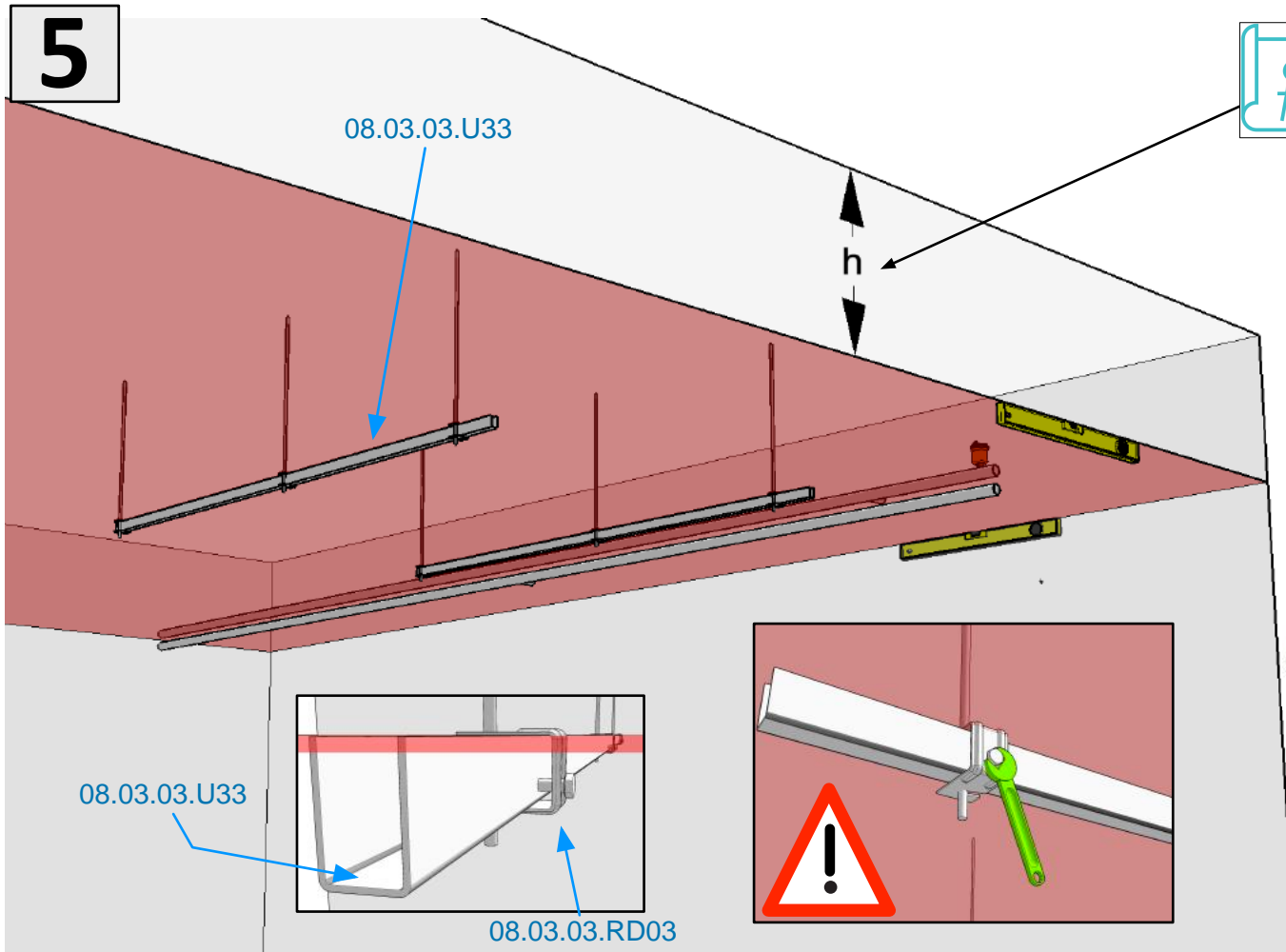

08.03.03.U33

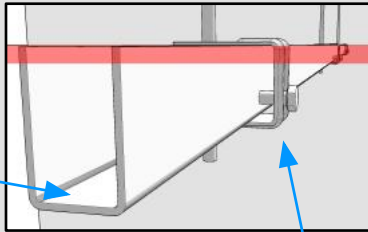

08.03.03.RD03

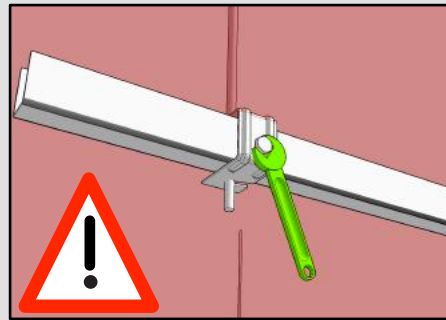

6

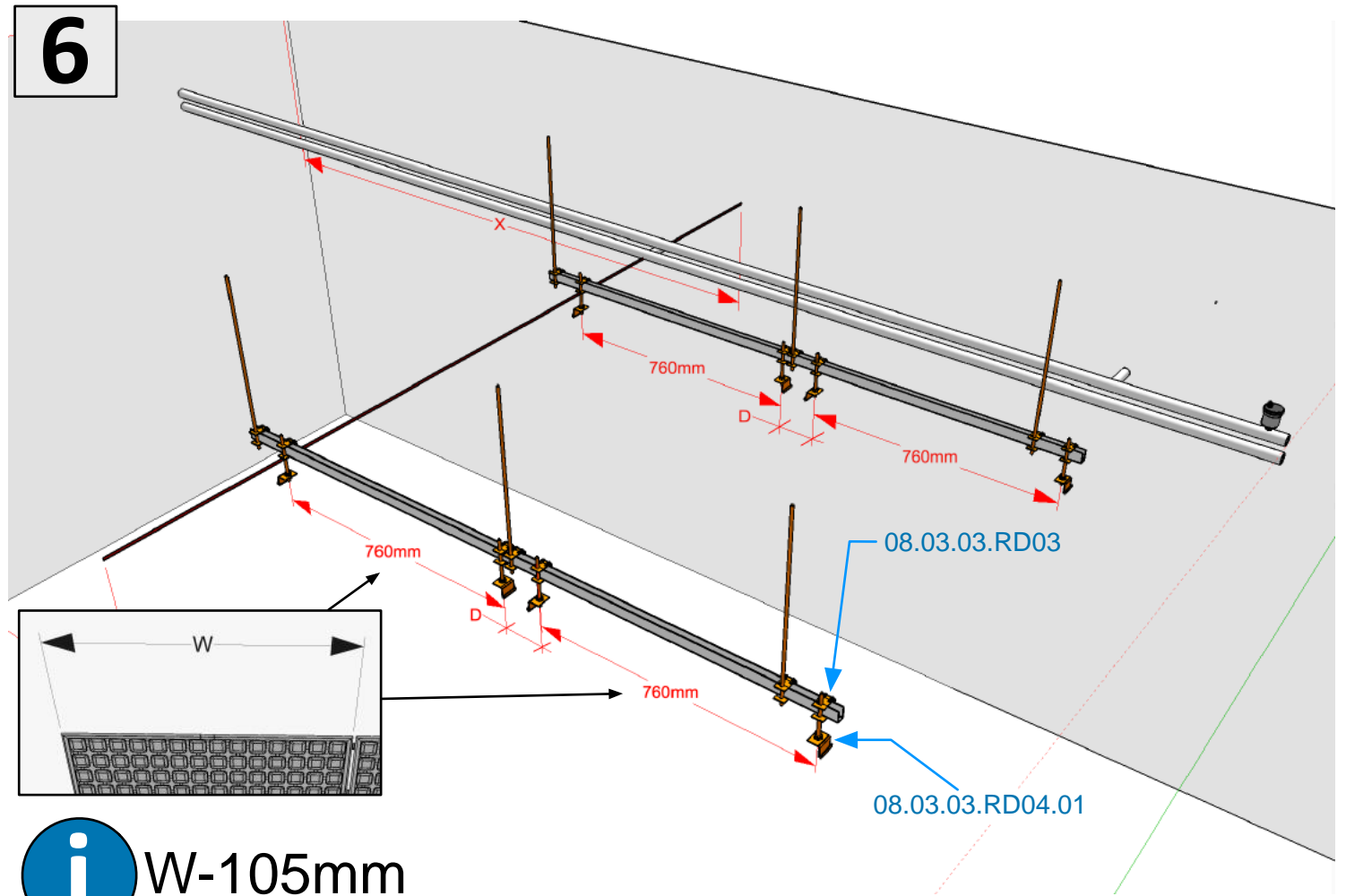

760mm

08.03.03.RD03

08.03.03.RD04.01

760mm

760mm

W



W-105mm

7

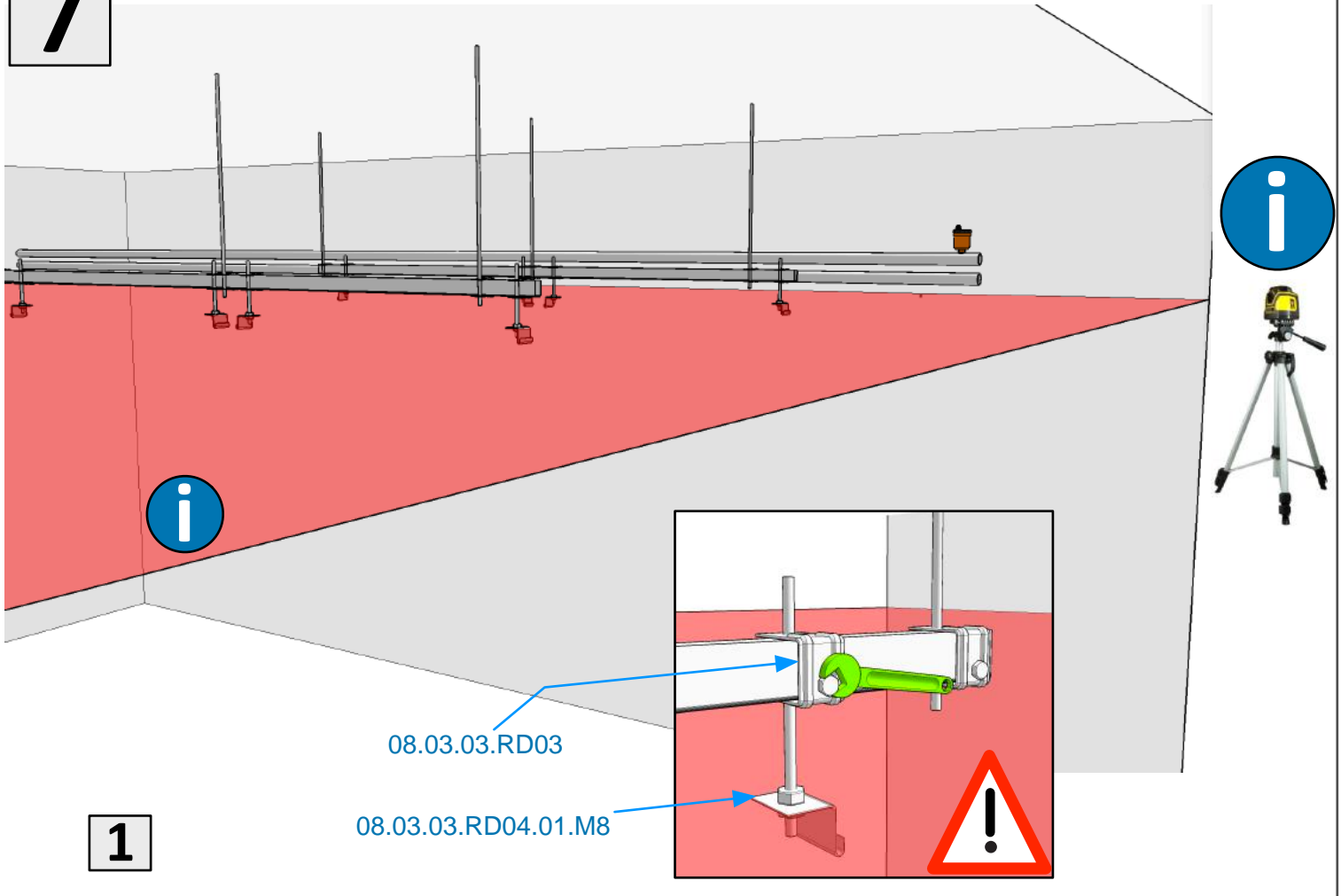

1

8

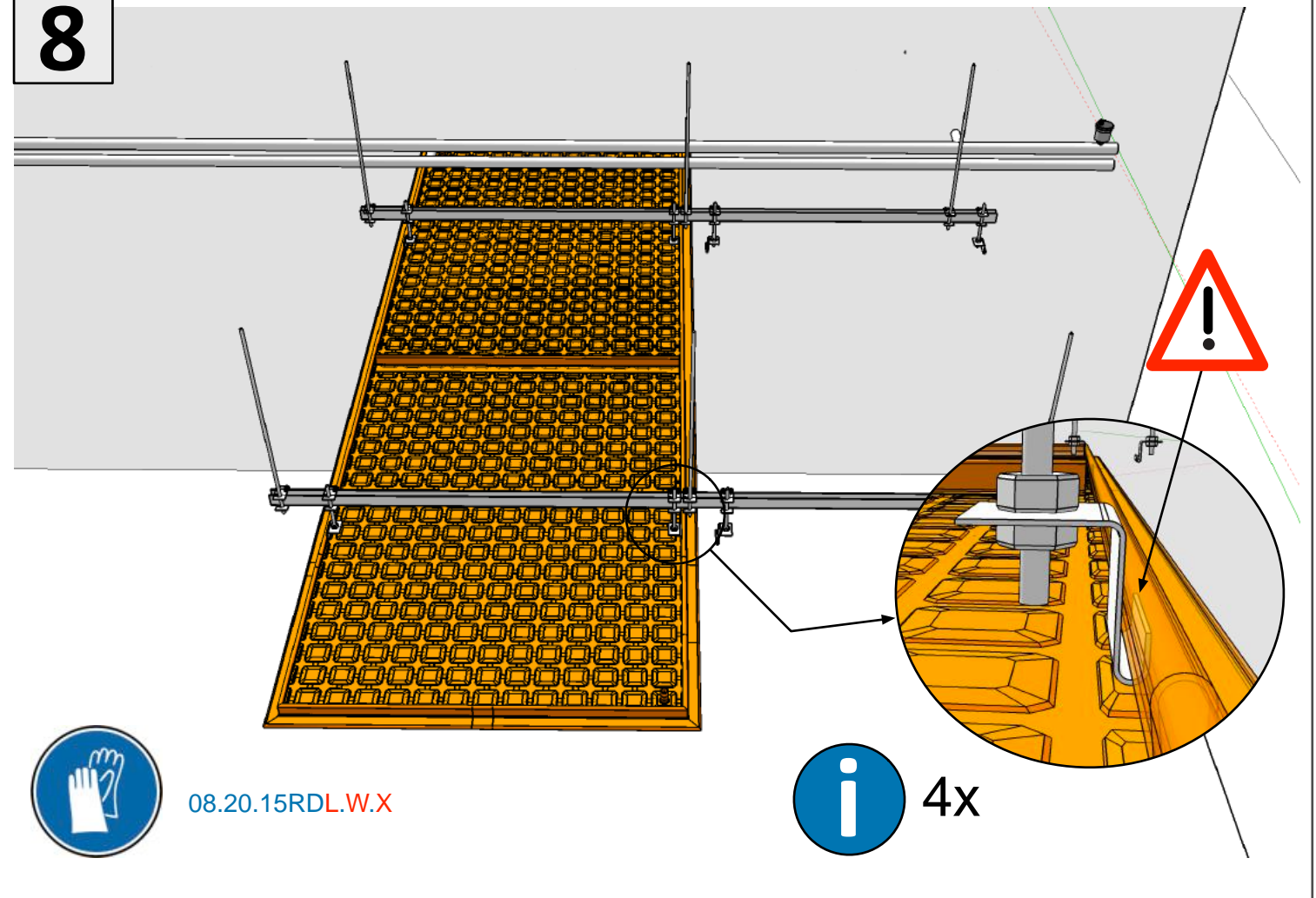

9

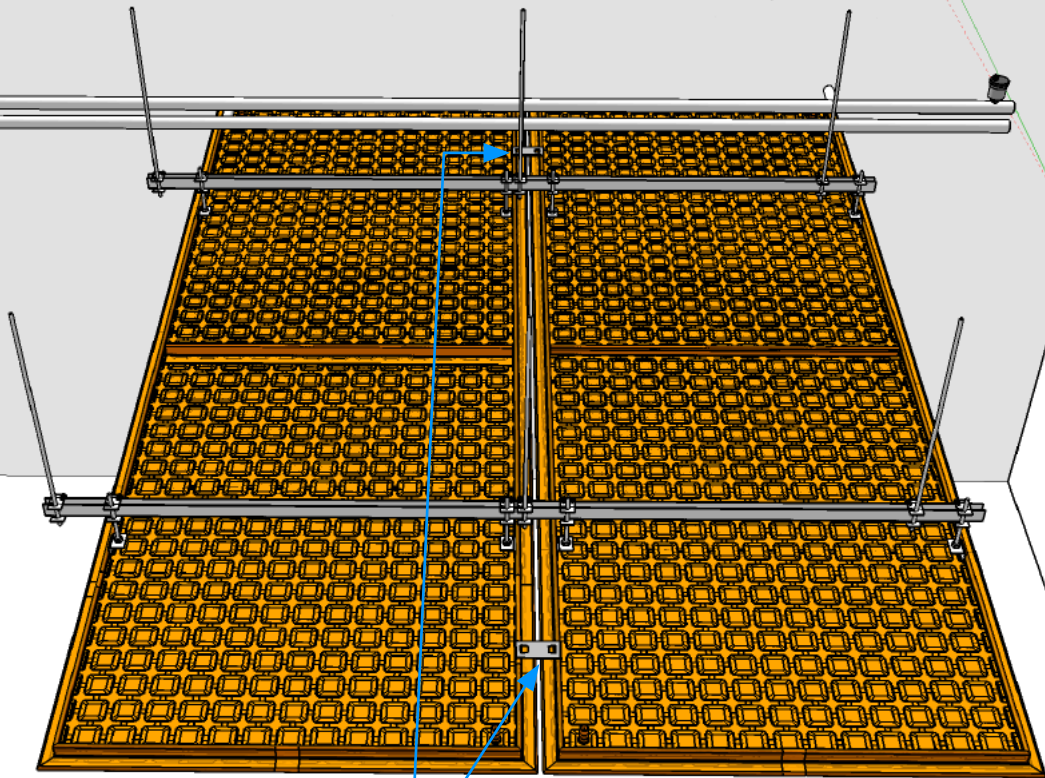

08.03.00.RD06



10

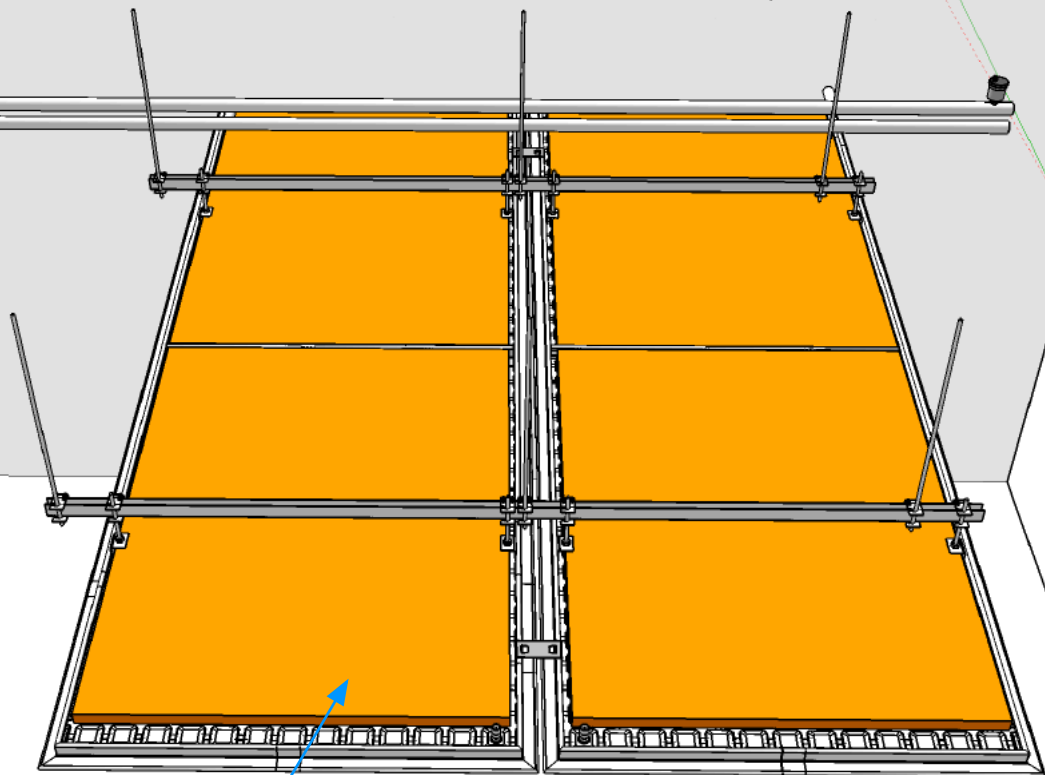

Option 08.05.RD15.LLL

11

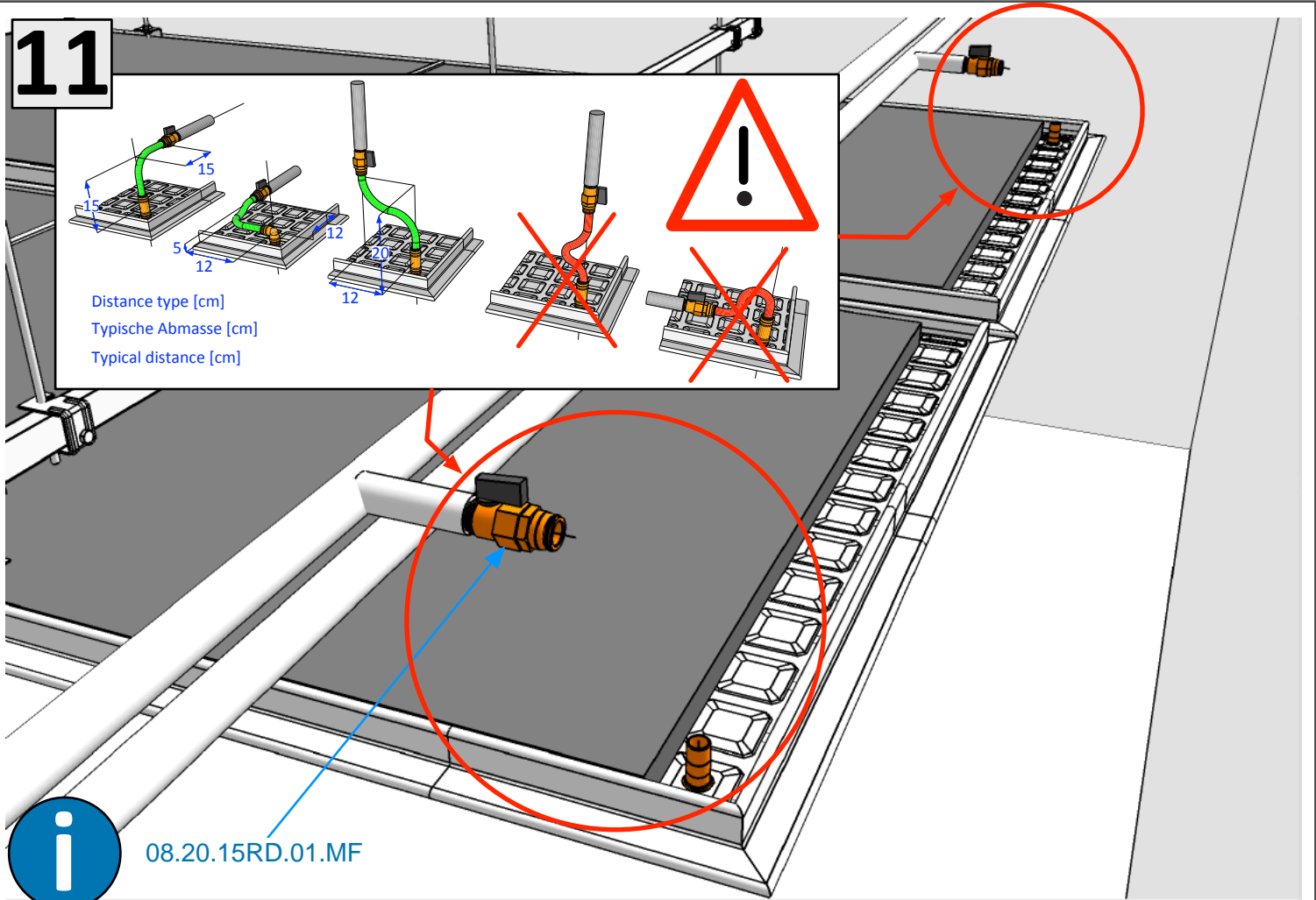

Distance type [cm]
Typische Abmasse [cm]
Typical distance [cm]

15, 12, 12, 20, 12

Warning: !



08.20.15RD.01.MF

12

08.20.15RD.GRAISSE

O-Ring silicon grease

Warning: !

22mm

22mm

22mm

crack !

max 2mm

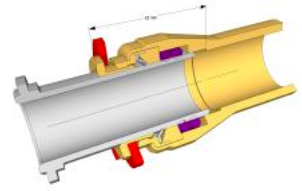

Information icon (i)

13

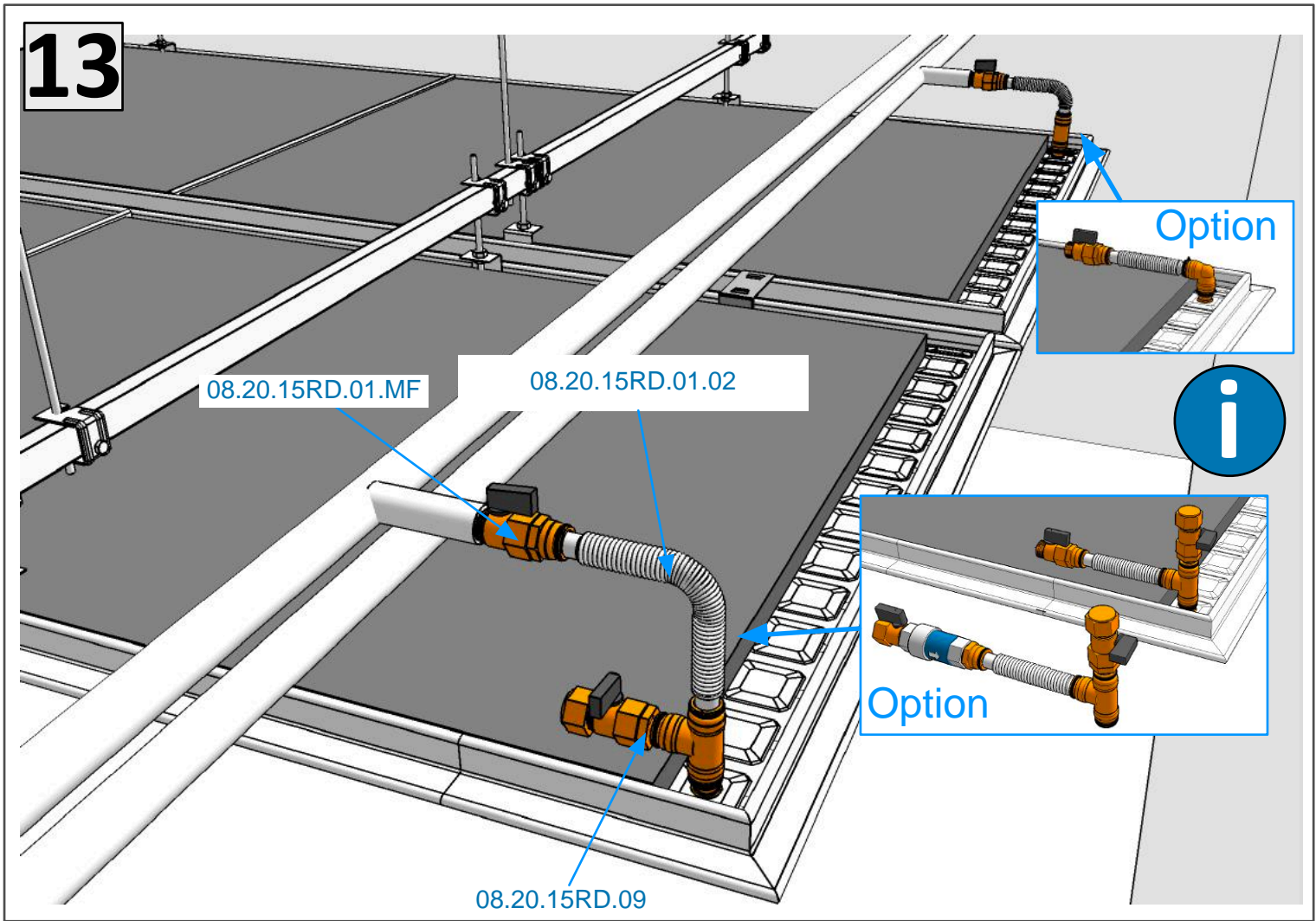

14

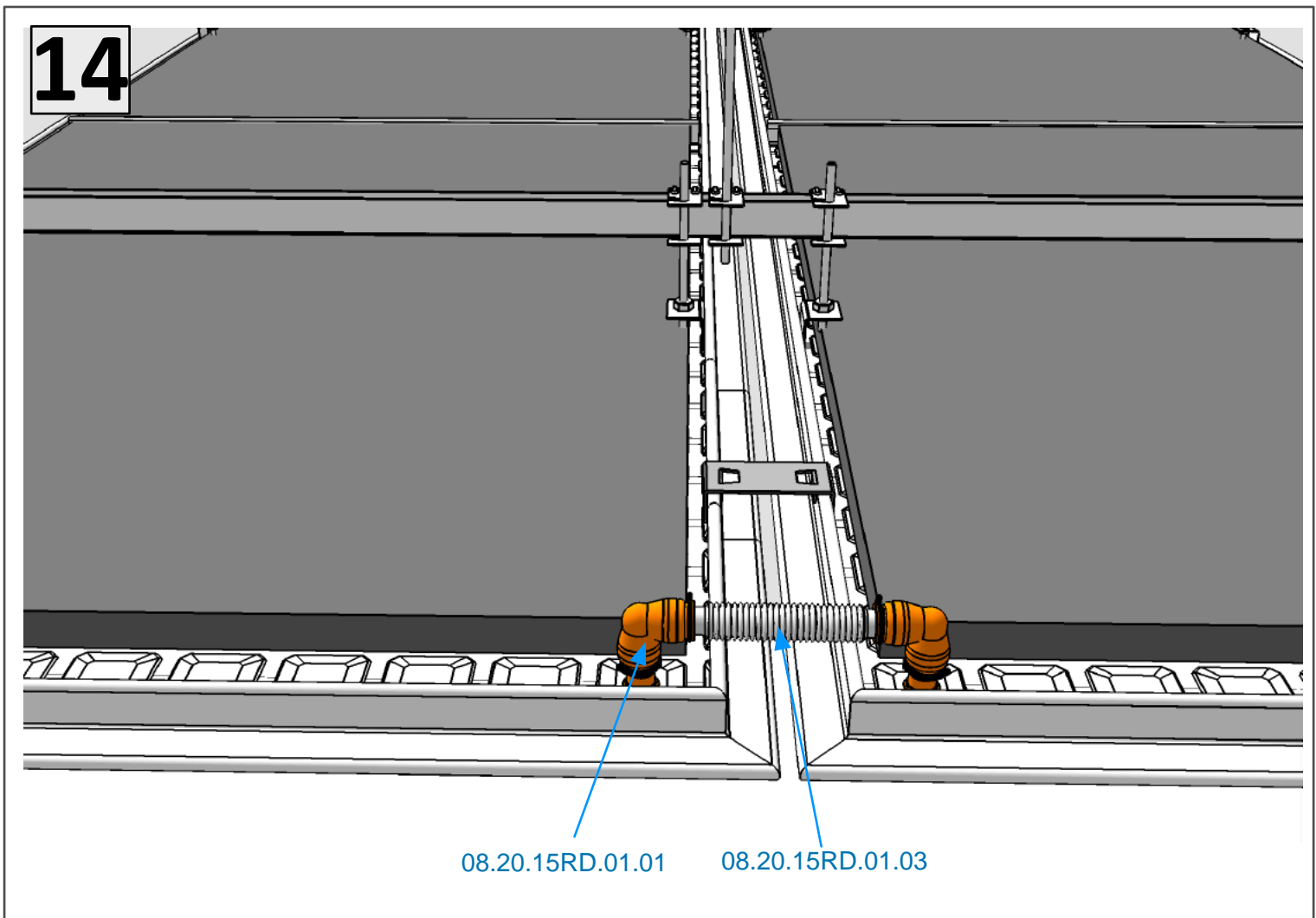

15

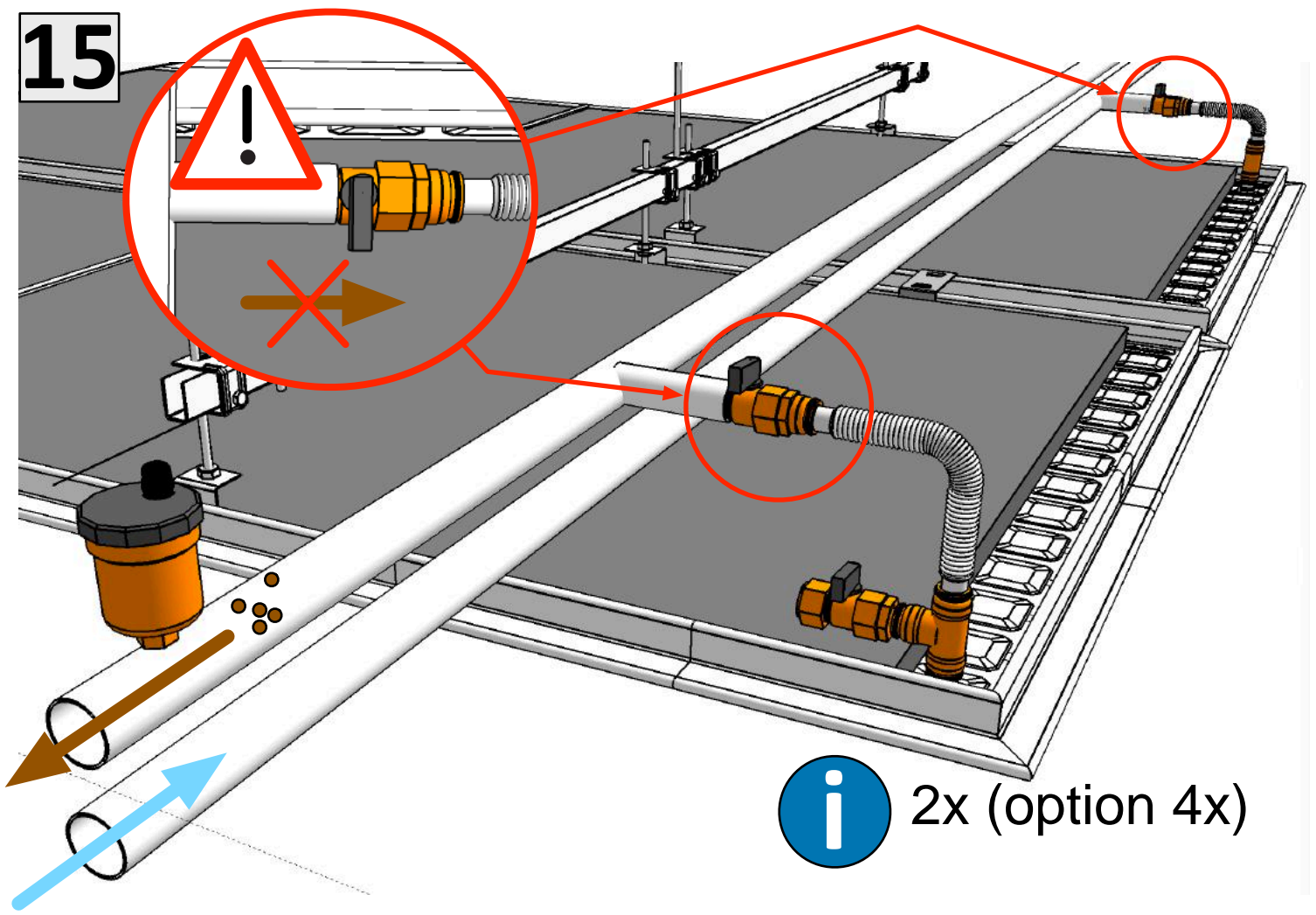

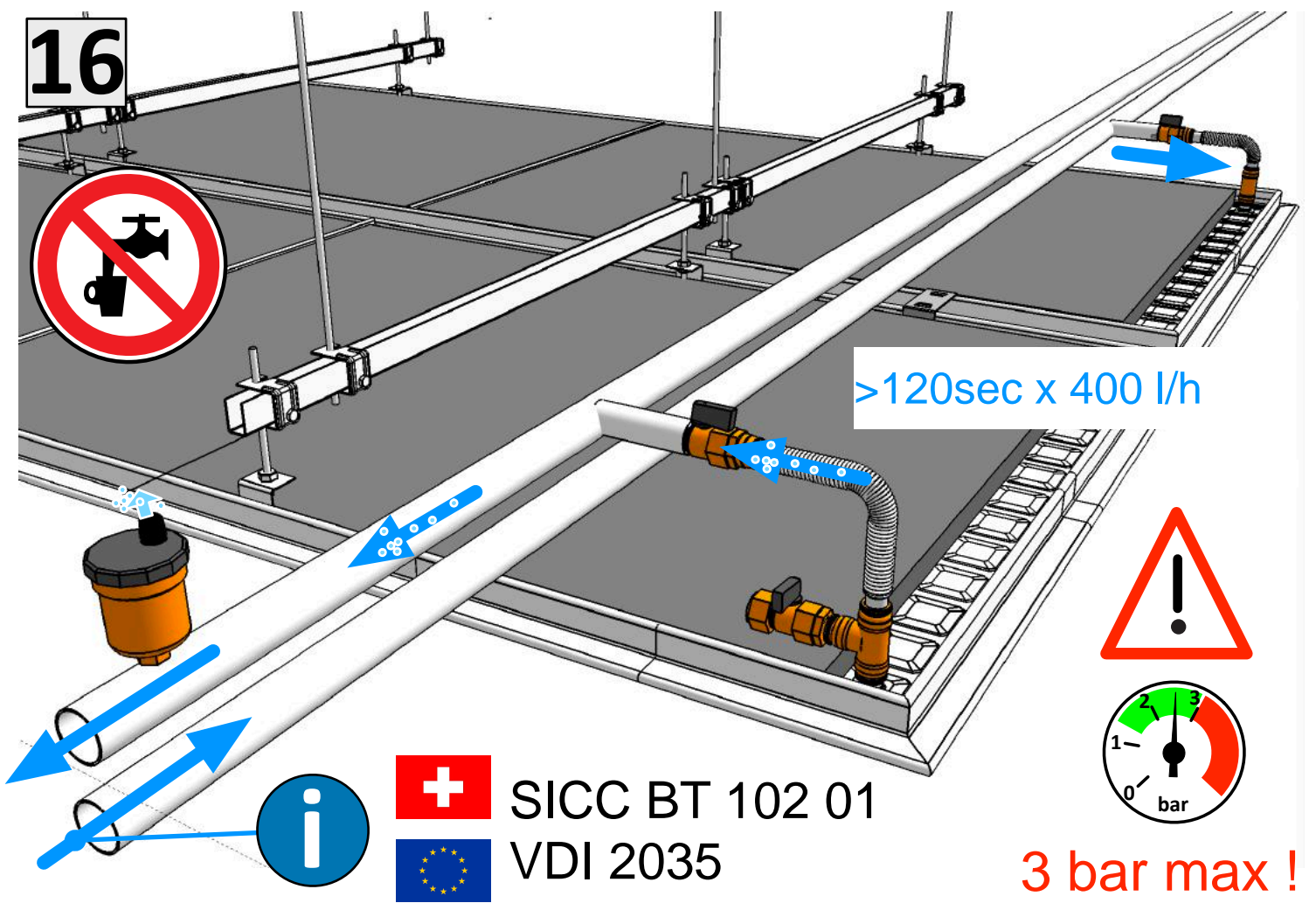

i 2x (option 4x)

16



>120sec x 400 l/h

 SICC BT 102 01
 VDI 2035

!

3 bar max !

17



2bar



ok?

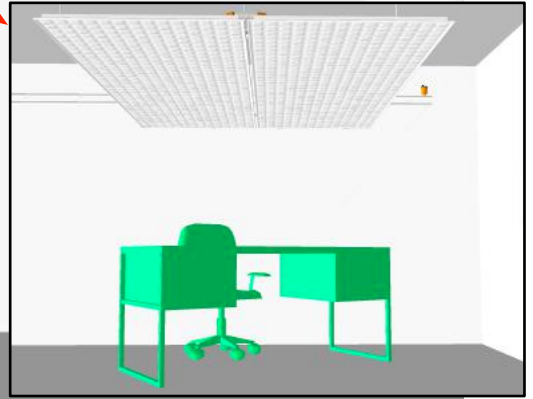

18

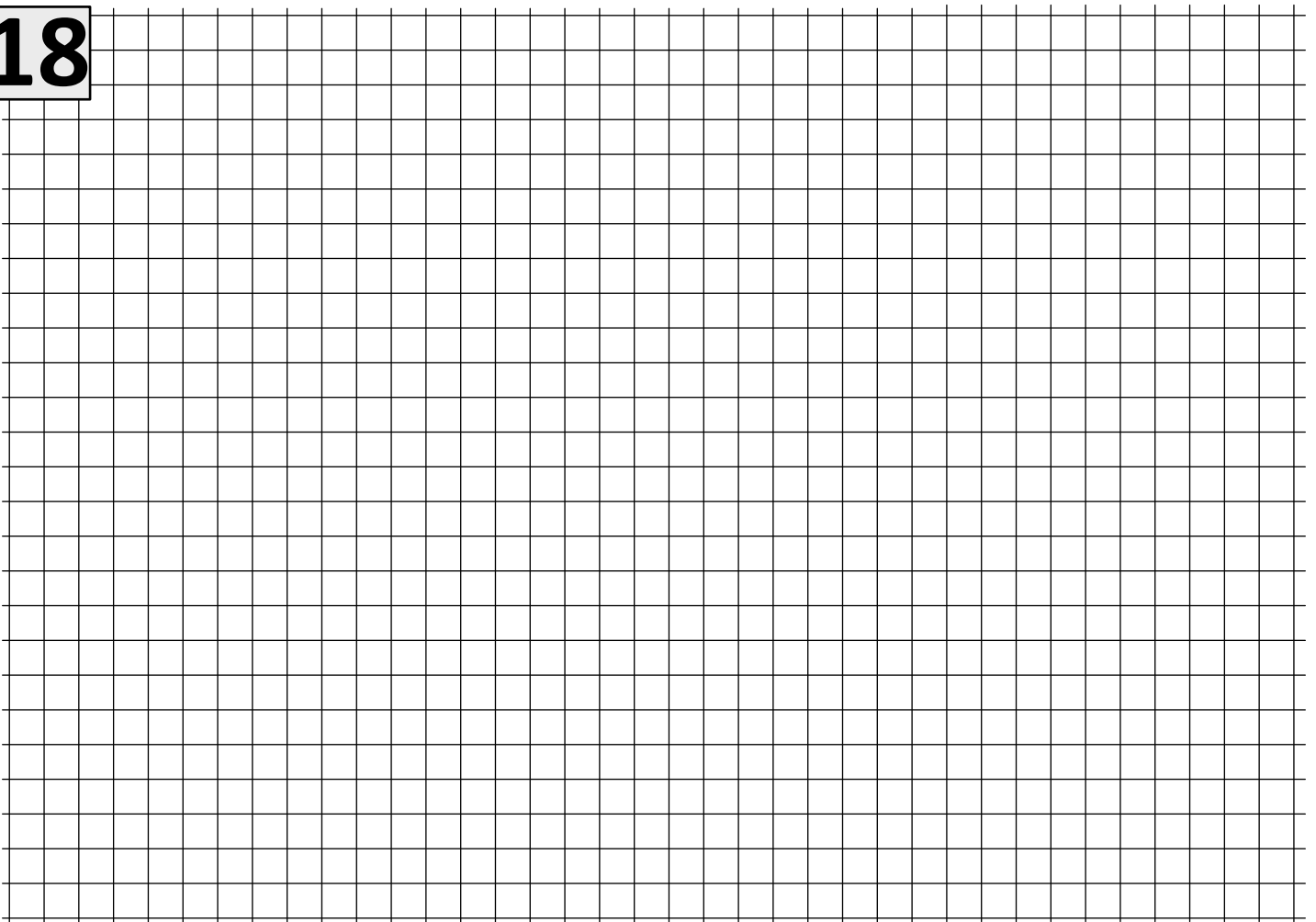



Contact :

Soltop Energie SA
ZI Ile Falcon
Rue des Sablons 8
CH-3960 Sierre

Soltop Energie AG
St.Gallerstrasse 3
CH-8353 Elgg

Tél.: +41 27 451 13 20

Tél.: +41 52 397 77 77

info@kigo-swiss.com
www.kigo-swiss.com